

# SR-17B

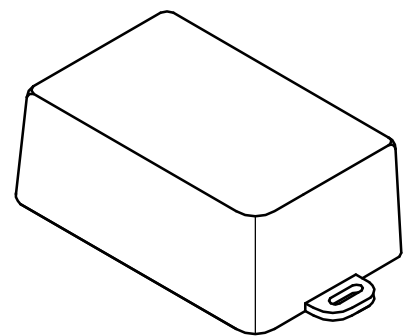
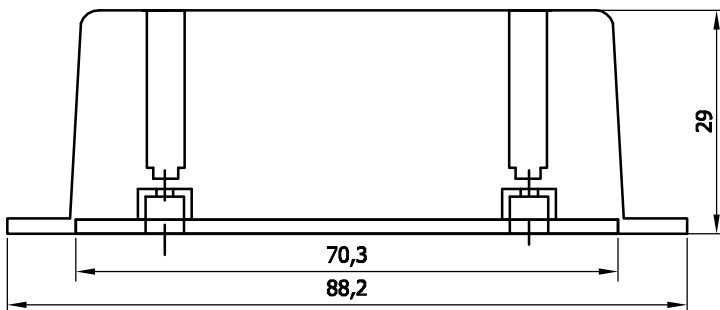
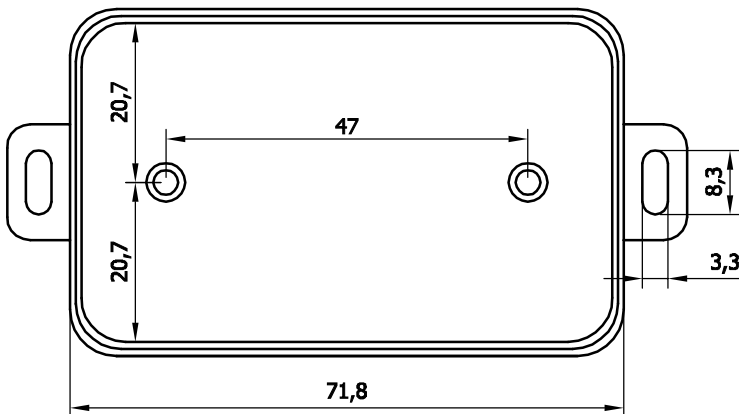
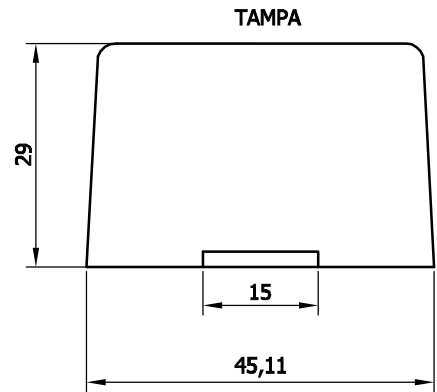
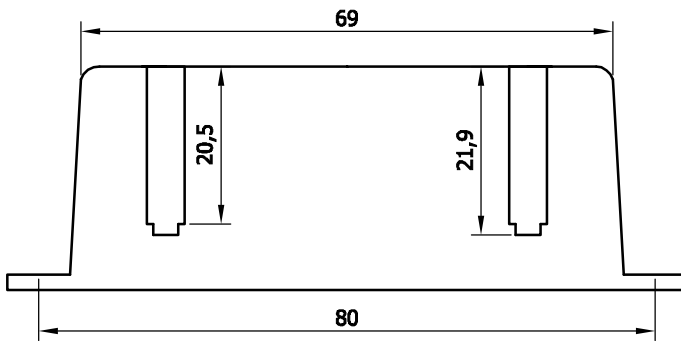
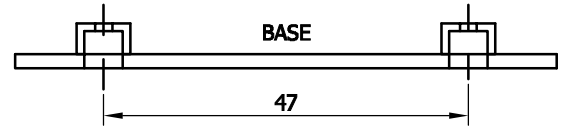
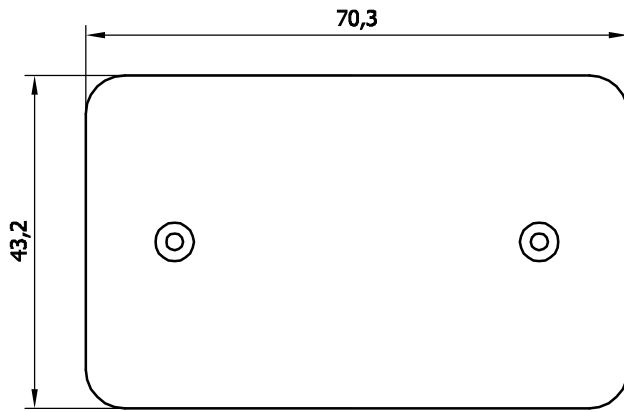

Obs: Utilizar parafuso 2,2mmx8mm ou 2,2mmx9,5mm

0	15/06/2012	Liberação
Rev.	Data	Descrição de Revisão

**SANTA RITA  
CAMPINAS**

Título: Caixa SR-17B SEM TORRE DE SUPORTE

Desenho nº: **SR-17B**

Folha:  
1 de 1

Escala:  
S/E

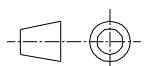

Arquivo: \\19

Desenhado por: Radamés

Revisado por: R. Toth

Aprovado por: Toth

PADRAO4.DWG

Formato A4 (210 x 297mm)